

Compressed Air Coalescing Filters

Models | A30006 to A31500

Flow Rates 6 SCFM (10 Nm³/hr) to 1500 SCFM (2550 Nm³/hr)

Introducing the Alpha Coalescing Filter, Walker Filtration's latest range of market leading compressed air and gas filters. With enhanced housing features and a step change in element performance, the Alpha delivers a high quality filtration solution you can trust.

Offered in a range of 19 models with connection sizes ranging from 1/8" to 3", the Alpha Series has been tested to provide a saturated differential pressure of <125 mbar across X1 and XA grades - proving to be our most advanced filter to date.

With class leading performance and exceptional results in oil aerosol and particle retention, the Alpha Filters deliver significantly reduced pressure loss and optimum filtration efficiencies - to ensure continually low operational costs.



Modular Filter

Low cost connecting kits and new filter head design enables easy close coupling assembly



NEW Filtration Technology

Alpha deep pleated media technology delivers a step change in performance



Externally Accessible Drain

Eliminates the need to access the inside of the filter housing when servicing the drain

- **Flow-Optimised Design** Advanced filter head design for optimised flow performance
- **Flexible Installation** Modular design and accessible fixings enable simple close coupling assembly
- **Market Leading Performance** Custom engineered filtration media delivers optimum performance in line with air quality standard ISO 8573-1: 2010
- **Simplified Serviceability** Externally accessible drain, profiled bowl design and unique push fit elements ensure quick and reliable maintenance
- **Corrosion Protection** Internal and external electrophoretic paint finish followed by a tough exterior polyester powder coating
- **Colour Coded Element End Caps** Easy and accurate grade identification
- **Product Safety in Mind** Guaranteed safe housing closure with rotational safety stop

For further information please visit www.walkerfiltration.com



Differential pressure of <125 mbar across X1 and XA grades





Technical Specification

Filter model	Pipe size inches	Inlet flow rate*		Dimensions mm				Weight Kg	Element model
		Nm ³ /hr	SCFM	A	B	C	D		
A30006 (grade)	1/8	10	6	50	17	157	60	0.3	E30306 (grade)
A30015 (grade)	1/4	25	15	50	17	157	60	0.3	E30306 (grade)
A30025 (grade)	1/4	42	25	70	23	231	70	0.6	E30408 (grade)
A30032 (grade)	3/8	54	32	70	23	231	70	0.6	E30408 (grade)
A30050 (grade)	1/2	85	50	70	23	231	70	0.6	E30412 (grade)
A30070 (grade)	1/2	119	70	127	32	285	80	1.7	E30612 (grade)
A30085 (grade)	3/4	144	85	127	32	285	80	1.7	E30612 (grade)
A30105 (grade)	1	178	105	127	32	285	80	1.7	E30612 (grade)
A30125 (grade)	3/4	212	125	127	32	370	80	2.0	E30621 (grade)
A30175 (grade)	1	297	175	127	32	370	80	2.0	E30621 (grade)
A30280 (grade)	1 1/4	476	280	140	41	476	85	3.0	E30731 (grade)
A30320 (grade)	1 1/2	544	320	140	41	476	85	3.0	E30731 (grade)
A30400 (grade)	1 1/2	680	400	170	53	508	100	4.9	E30831 (grade)
A30450 (grade)	2	765	450	170	53	508	100	4.9	E30831 (grade)
A30700 (grade)	2	1189	700	170	53	708	100	5.5	E30850 (grade)
A30850 (grade)	2 1/2	1444	850	220	70	736	100	10.5	E31140 (grade)
A30900 (grade)	3	1529	900	220	70	736	100	10.5	E31140 (grade)
A31250 (grade)	3	2125	1250	220	70	857	100	11.5	E31160 (grade)
A31500 (grade)	3	2550	1500	220	70	1005	100	12.5	E31175 (grade)

* Rated flow at 7 barg, reference conditions at 1 bar (a) 20°C

Grade	X25		X5		X1		XA		AC	
Particle removal	25 micron		5 micron		1 micron		0.01 micron		0.01 micron	
Maximum particle size class**	-		4		3		1		1	
Maximum oil content**	-		4		3		1		1	
Maximum oil carryover at 20°C (68°F)	10 mg/m ³		5 mg/m ³		0.3 mg/m ³		0.01 mg/m ³		0.003 mg/m ³	
Pressure loss - clean & dry	30 mbar	0.4 psi	40 mbar	0.6 psi	55 mbar	0.8 psi	85 mbar	1.2 psi	115 mbar	1.7 psi
Pressure loss - saturated	50 mbar	0.7 psi	75 mbar	1.1 psi	125 mbar	1.8 psi	125 mbar	1.8 psi	N/A	N/A
Pressure loss - element change	12 mths	8000 hrs	12 mths	8000 hrs	12 mths	8000 hrs	12 mths	8000 hrs	at least every 6 mths	
Maximum temperature - automatic drain	80°C	176°F	80°C	176°F	80°C	176°F	80°C	176°F	50°C***	122°F***
Maximum working pressure - automatic drain	16 barg	232 psig	16 barg	232 psig	16 barg	232 psig	16 barg	232 psig	16 barg	232 psig
Maximum temperature - manual drain	120°C	248°F	120°C	248°F	120°C	248°F	120°C	248°F	50°C***	122°F***
Maximum working pressure - manual drain	20.7 barg	300 psig	20.7 barg	300 psig	20.7 barg	300 psig	20.7 barg	300 psig	20.7 barg	300 psig
Element end cap colour	Black		Green		Red		Blue		Black	

** to ISO 8573-1: 2010 *** Maximum recommended operating temperature 25°C (77°F)

Pressure correction factors	For maximum flow rate, multiply model flow rate by the correction factor corresponding to the minimum operating pressure										
	Operating pressure barg (psig)	4 (58)	5 (72)	6 (87)	7 (100)	8 (115)	10 (145)	12 (174)	14 (203)	16 (232)	20.7 (300)
7 barg - correction factor	0.76	0.84	0.92	1	1.07	1.19	1.31	1.41	1.51	1.73	

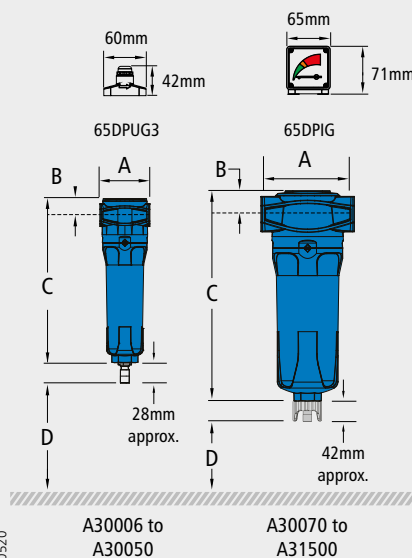

Technical Notes

- Direction of air flow is inside to out through the filter element.
- Pop up indicators (65DPUG3) are fitted to models A30025 to A30050 as standard. Differential pressure indicators (65DPIG) are fitted to models A30070 to A31500 as standard. Activated Carbon (AC) grade filters do not include DP equipment. Volt free contact options are available upon request - see price guide.
- Coalescing Filters are fitted as standard with normally open float operated automatic drain valves, ADVS16 on models A30006 to A30050 ADVSE16 on models A30070 to A31500. Standard filters can operate at 16 barg (232 psig) at 80°C (176°F). Normally closed automatic drain valves (ADV516C) are available for low flow applications. 20.7 bar range (300 psi) at 120°C (248°F) available when supplied with a manual drain valve (MDV25 / MDVE25).
- Activated Carbon Filters must not operate in oil saturated conditions and will not remove certain types of gases including carbon monoxide (CO) and carbon dioxide (CO₂).
- New Alpha Filters are manufactured from cast aluminium alloy and are PED 2014/68/EU compliant for group 2 gases.
- Threaded connections are Rp (BSP Parallel) to ISO 7-1 or NPT to ANSI/ASME B1.20.1 if supplied within North America. Rc (BSP Taper) to ISO 7-1 also available.
- For NPT threads, add the suffix N, e.g., A30070NXA, and for Rc threads add the suffix C, e.g. A30070CXA.
- Filters are suitable for use with mineral and synthetic oils plus, oil-free compressed air applications.

